

BEDU
≡ POMPEN ≡

*Horizontal multi-stage close coupled pumps

MXP, MGP, MXA



OPERATING INSTRUCTIONS

made for your process

SUMMARY

1. GENERAL INFORMATION
2. TECHNICAL DESCRIPTION
3. TECHNICAL FEATURES
4. SAFETY
5. TRANSPORTATION AND HANDLING
6. INSTALLATION
7. STARTUP AND OPERATION
8. MAINTENANCE
9. DISPOSAL
10. SPARE PARTS
11. ESIGNATION OF PARTS
12. TROUBLESHOOTING

Installation examples

Drawing for dismantling and assembly

Declaration of conformity

1. GENERAL INFORMATION

Before using the product carefully read the information contained in this instruction manual, the manual should be kept for future reference.

Italian is the original language of this instruction manual, this language is the reference language in case of discrepancies in the translations.

This manual is part of the essential safety requirement and must be retained until the product is finally decommissioned.

The customer, in case of loss, can request a copy of the manual by contacting Bedu Pompen BV or their agent, specifying the type of product data shown on the label of the machine (see 2.3 Marking)

Any changes, alterations or modifications made to the product or part of it, not authorized by the manufacturer, will revoke the "CE declaration" and warranty.

This appliance should not be operated by children younger than 8 years, people with reduced physical, sensory or mental capacities, or inexperienced people who are not familiar with the product, unless they are given close supervision or instructions on how to use it safely and are made aware by a responsible person of the dangers its use might entail.

Children must not play with the appliance.

It is the user's responsibility to clean and maintain the appliance. Children should never clean or maintain it unless they are given supervision.

Do not use in ponds, tanks or swimming pools or where people may enter or come into contact with the water.

Read carefully the installation

section which sets forth:

- The maximum permissible structural working pressure (chapter 3.1).
- The type and section of the power cable (chapter 6.5).
- The type of electrical protection to be installed (chapter 6.5).

1.1. Symbols

To improve the understanding of the manual, below are indicated the symbols used with the related meaning.



Information and warnings that must be observed, otherwise there is a risk that the machine could damage or compromise personnel safety.



The failure to observe electrical information and warnings, could damage the machine or compromise personnel safety.



Notes and warnings for the correct management of the machine and its parts.



Operations that could be performed by the final user. After carefully reading of the instructions, is responsible for maintenance under normal conditions. They are authorized to affect standard maintenance operations.



Operations that must be performed by a qualified electrician. Specialized technician authorised to affect all electrical operations including maintenance. They are able to operate with in the presence of high voltages.



Operations that must be done performed by a qualified technician. Specialized technician able to install the device, under normal conditions, working during "maintenance", and allowed to do electrical and mechanical interventions for maintenance. They must be capable of executing simple electrical and mechanical operations related to the maintenance of the device.



Indicates that it is mandatory to use individual protection devices.



Operations that must be done with the device switched off and disconnected from the power supply.



Operations that must be done with the device switched on.

1.2. Manufacturer name and address

Bedu Pompen B.V.

Poort van Midden Gelderland Rood 10

6666 LT HETEREN, The Netherlands

1.3. Authorized operators

The product is intended for use by expert operators divided into end users and specialized technicians. (see the symbols above).



It's forbidden, for the end user, carry out operations which must be done only by specialized technicians. The manufacturer declines any liability for damage related to the non-compliance of this warning.

1.4. Warranty

For the product warranty refer to the general terms and conditions of sale.

 The warranty covers only the replacement and the repair of the defective parts of the goods (recognized by the manufacturer).

The Warranty will not be considered in the following cases:

- Whenever the use of the device does not conform to the instructions and information described in this manual.
- In case of changes or variations made without authorization of the manufacturer.
- In case of technical interventions executed by a non-authorized personnel.
- In case of failing to carry out adequate maintenance.

1.5. Technical assistance

Any further information about the documentation, technical assistance and spare parts, shall be requested from: Bedu Pompen BV (paragraph 1.2).

2. TECHNICAL DESCRIPTION

Horizontal Multi-Stage Close Coupled Pumps (self-priming pumps MXA-series).

MXP: version with pump casing in AISI 304 with impeller PPO-GF20.

MGP: version with pump casing in Cast iron with impeller PPO-GF20.

MXA: version with pump casing in AISI 304 with impeller PPO-GF20.

2.1. Intended use

For clean liquids: non-explosive and non-flammable, non-hazardous for health or the environment, non-aggressive for pump materials, not containing abrasives, solid or fibrous particles.

Liquid temperature from - 0 °C to + 50 °C (from 0 °C to + 35 °C for MXA).

2.2. Improper use

The device is designed and built only for the purpose described in paragraph 2.1.

 Improper use of the device is forbidden, as is use under conditions other than those indicated in these instructions.

Improper use of the product reduces the safety and the efficiency of the device, Bedu shall not be responsible for failure or accident due to improper use.

 Do not use in ponds, tanks or swimming pools or where people may enter or come into contact with the water.

2.3. Marking

The following picture is a copy of the name-plate that is on the external case of the pump.

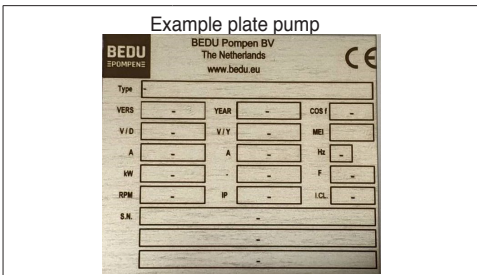

3. TECHNICAL FEATURES

3.1. Technical data

Dimensions and weight (see technical catalogue).

Nominal speed 2900/3450 rpm

Protection IP54

Supply voltage / Frequency:

- up to 240V 1~ 50/60 Hz

- up to 480V 3~ 50/60 Hz

Check that the mains frequency and voltage correspond to the electrical characteristics shown on the indicator plate.

The electric data marked on the label are referred to the nominal power of the motor.

Sound pressure: < 70 dB (A).

Max. starts per hour: 15 at regular intervals.

Maximum permissible pressure in the pump casing: 80 m (8 bar).

3.2. Operating conditions

Installation in well ventilated location protected from the weather, with a maximum ambient temperature of 40 °C.

4. SAFETY

4.1. General provisions

 Before using the product it is necessary to know all the safety indications.

Carefully read all operating instructions and the indications defined for the different steps: from transportation to disposal.

The specialized technicians must carefully comply with all applicable standards and laws, including local regulations of the country where the pump is sold.

The device has been built in conformity with the current safety laws. The improper use could damage people, animals and objects.

The manufacturer declines any liability in the event of damage due to improper use or use under conditions other than those indicated on the name-plate and in these instructions.

 Follow the routine maintenance schedules and the promptly replace damaged parts, this will allow the device to work in the best conditions.

Use only original spare parts provided from Bedu Pompen BV or from an authorized distributor.

 Don't remove or change the labels placed on the device.

Do not start the device in case of defects or damaged parts.

 Maintenance operations, requiring full or partial disassembly of the device, must be done only after disconnection from the supply.

4.2. Safety devices

The device has an external case that prevents any contact with internal parts.

4.3. Residual risks

The appliance, designed for use, when used in-line with the design and safety rules, doesn't have residual risks.

4.4. Information and Safety signals

For this kind of product there will not be any signals on the product.

4.5. Individual protection devices

During installation, starting and maintenance it is suggested to the authorized operators to consider the use of individual protection devices suitable for described activities.

During ordinary and extraordinary maintenance interventions, safety gloves are required.

Signal



individual protection device
HAND PROTECTION
(gloves for protection against chemical, thermal and mechanical risks).

5. TRANSPORTATION AND HANDLING

The product is packed to maintain the content intact. During transportation avoid to stack excessive weights. Ensure that during the transportation the box cannot move.

It is not necessary to use any special vehicle to transport the packaged device.

The transport vehicles must comply, for the weight and dimensions, with the chosen product (see technical catalogue dimensions and weights).

5.1. Handling

Handle with care, the packages must not receive impacts.

Avoid to impact onto the package materials that could damage the pump.

If the weight exceeds 25 Kg the package must be handled by two person at the same time.

6. INSTALLATION

6.1. Dimensions

For the dimensions of the device (see technical catalogue).

6.2. Ambient requirements and installation site dimensions

The customer has to prepare the installation site in order to guarantee the right installation and in order to fulfill the device requirements (electrical supply, etc...). The place where the device will be installed must fulfill the requirements in the paragraph 3.2.

It's Absolutely forbidden to install the machine in an environment with potentially explosive atmosphere.

6.3. Unpacking



Inspect the device in order to check any damages which may have occurred during transportation.

Package material, once removed, must be discarded/recycled according to local laws of the destination country.

6.4. Installation

See installation examples, par. 13 fig. 1 and 2.

The pumps must be installed with the rotor axis in the horizontal position and with the feet under the pump. Place the pump as close as possible to the suction source.

Provide space around the pump for motor ventilation, to allow for checking of shaft rotation, for filling and draining the pump and to allow for collection of the liquid to be removed.

6.4.1. Pipes

Ensure the insides of pipes are clean and unobstructed before connection.

ATTENTION: The pipes connected to the pump should be secured to rest clamps so that they do not transmit stress, strain or vibrations to the pump (par. 13 fig. 3).

Tighten the pipes or union coupling to the extent sufficient to ensure a tight seal (par. 13 fig. 6).

Excessive torque may cause damage to the pump. When the pipe or union coupling is mounted, keep the pump casing connection blocked with a second wrench, making sure the connection is not deformed by excessive tightening.

The pipe diameters must not be smaller than the pump connections.

6.4.2. Suction pipe

If the suction pipe is longer than 10 m, use an internal pipe diameter larger than the pump suction connection. For capacities over 4 m³/h use a suction pipe G 1 1/4 (DN 32).

The suction pipe must be perfectly airtight and be led upwards in order to avoid air pockets.

With a pump located above the water level (suction lift operation, par. 13, fig. 2) fit a foot valve with strainer which must always remain immersed (or a check valve on the suction connection for MXA).

If operating with flexible hoses use a reinforced spiral suction hose, in order to avoid the hose narrowing due to suction vacuum.

With the liquid level on the suction side above the pump (inflow under positive suction head, par. 13, fig. 1) fit an inlet gate valve.

For suction from a storage tank fit an anti-backflow valve. Follow local specifications if increasing network pressure.

Install a strainer on the suction side of the pump to prevent foreign particles from entering the pump.

6.4.3. Delivery pipe

Fit a gate valve in the delivery pipe to adjust delivery and head.

Install a pressure gauge.

With a geodetic head at outlet over 15 m fit a check valve between the pump and the gate valve in order to protect the pump from water hammering.

6.5. Electrical connection



Electrical connection must be carried out only by a qualified electrician in accordance with local regulations.

Follow all safety standards.

The unit must be properly earthed (grounded).

Connect the earthing (grounding) conductor to the terminal with the ⊕ marking.

Compare the frequency and mains voltage with the name-plate data and connect the supply conductors to the terminals in accordance with the appropriate diagram inside the terminal box cover.



ATTENTION: never allow washers or other metal parts to fall into the internal cable opening between the terminal box and stator. If this occurs, dismantle the motor to recover the object which has fallen inside.

If the terminal box is provided with an inlet gland, use a flexible power supply cord of the H07 RN-F type with section of cable not less than (par. 13.2 TAB 1).

If the terminal box is provided with an inlet bushing,

connect the power supply cord through a conduit. For use in swimming pools (not when persons are in the pool), garden ponds and similar places, a **residual current device** with I_{ΔN} not exceeding 30 mA must be installed in the supply circuit.

Install a **device for disconnection from the mains** (switch) with a contact separation of at least 3 mm in all poles.

With a three-phase motor install an overload protection device with curve D appropriate for the rated current of the pump.

Single-phase, are supplied with a capacitor connected to the terminals and (for 220-240 V - 50 Hz) with an incorporated thermal protector.



ATTENTION: When the pump is fed by a frequency converter, the minimum frequency should not fall below 25Hz and in any case the total head of the pump should never be lower than 3 m.

7. STARTUP AND OPERATION

7.1. Preliminary checks before start-up of the pump

Do not start-up the device in case of damaged parts.

7.2. First starting



ATTENTION: never run the pump dry. Start the pump after filling it completely with liquid.

When the pump is located above the water level (suction lift operation par. 13 fig. 2) or with a positive suction head which is too low (less than 1 m) to open the non-return valve, fill the pump through the priming hole (par. 13 fig. 4).

When the liquid level on the suction side is above the pump (inflow under positive suction head par. 13 fig. 1), fill the pump by opening the suction gate valve slowly and completely, keeping the delivery gate valve open to release the air.

Before starting, check that the shaft turns by hand. For this purpose use the screwdriver notch on the shaft end on the ventilation side.

When starting, with a three-phase motor, check that the direction of rotation is as shown by the arrows on the lantern bracket.

Otherwise, disconnect electrical power and reverse the connections of two phases.

Check that the pump works within its field of performance and that the absorbed current shown on the name-plate is not exceeded. Otherwise adjust the delivery gate valve or the setting of any pressure switches.

If a priming loss occurs (interruption of delivery flow) or if a pressure oscillation is indicated by the pressure gauge, make sure all the suction pipe couplings are perfectly sealed and tighten the two sealed plugs on the pump casing.



Never run the pump for more than five minutes with a closed gate valve.

Prolonged operation without a change of water in the pump causes dangerous increases of temperature and pressure.

When the water is overheated due to prolonged operation with a closed port, stop the pump before opening the gate valve.

To avoid any risk of danger to users and the creation of harmful thermal stress in the pump and system due to large temperature differentials, wait until the water has

cooled inside the pump before starting again.

If the water is overheated on account of prolonged operation with a non-primed or insufficiently filled pump (suction lift operation), wait until cool before opening the draining and filling plugs.



Care must be taken when the pumped fluid has a high temperature. Do not touch the fluid when its temperature is higher than 60 °C. Do not touch the pump when the surface temperature is higher than 80 °C.

GB

7.3. Automatic regulator IDROMAT

(can be supplied on request)

For automatic control of starting/stopping of the pump when utilization points are opened/closed.

For protection of the pump:

- against dry running;
 - against the risk of operation without water at the inlet (caused by a lack of water inflow in the inlet pipe under positive suction head, by a non-immersed suction pipe, by excessive suction lift or by air entering the suction pipe);
 - against operation with closed connection ports.
- See installation examples par. 13 fig. 1, fig. 2.

7.4. Self-priming (Only for MXA)

(Capability to clear the air in the suction pipe when starting with the pump located above the water level).

Conditions for self-priming:

- suction pipe with connections perfectly airtight and properly immersed in the water to be lifted;
- discharge pipe with a straight vertical free line above discharge port, before a non-return valve par. 13 fig. 1.
- **pump casing completely filled with clean cold water before starting.**

The pump is not self-priming with liquids containing oil, alcohol or foaming substances.

The check valve (par. 13 fig. 1) prevents reverse siphoning through the pump when the pump is stopped and retains water in the pump for the next start.

Without a foot valve or a check valve on the suction connection the filling operation must be repeated before each start-up.



ATTENTION: avoid a prolonged operation with unprimed pump, without water delivery from the completely opened outlet. If the pump does not prime in 5 minutes: stop the motor, remove the priming plug and add more water.

If necessary, repeat the priming operation after the pump has been first emptied and then completely filled with clean cold water.

7.5. Switch off of the pump



The appliance must be switch off every time there are faults. (see troubleshooting).

The product is designed for a continuous duty, the switch off is performed by disconnecting the power supply by means the expected disconnecting devices. (see paragraph "6.5 Electrical connection").

8. MAINTENANCE

Before any operations it's necessary to disconnect the power supply.

If required ask to an electrician or to an expert technician.



Every maintenance operations, cleaning or repairation executed with the electrical system under voltage, it could cause serious injuries to people.



If the supply cord is damaged, it must be replaced by the manufacturer, its service agent or similarly qualified persons in order to avoid a hazard.

In case of extraordinary maintenance, or maintenance operations that require part-removing, the operator must be a qualified technician able to read schemes and drawings.

It is suggest to register all maintenance operation executed.



During maintenance keep particular attention in order to avoid the introduction of small external parts, that could compromise the device safety.



It is forbidden to execute any operations with the direct use of hands. Use water-resistant, anti-cut gloves to disassemble and clean the filter or in other particular cases.



During maintenance operations external personnel is not allowed.

Maintenance operations that are not described in this manual must be made only by special personnel authorized by Bedu Pompen B.

For further technical information regarding the use or the maintenance of the device, contact Bedu Pompen

8.1. Routine maintenance



Before every maintenance operations disconnect the power supply and make sure that the device could not accidentally operate.



In the case of water containing chloride (chlorine, sea water), the risk of corrosion increases in stagnant water condicions (also with an increase in temperature and decrease of pH value). In these cases, **if the pump remains inactive for long periods, it must be emptied completely and, preferably, dried.**



For good measure, as in the case of **temporary operation with dirty liquids**, run the pump briefly with clean water to remove deposits.

When the pump remains inactive it must be emptied completely if there is a risk of freezing (par. 13 fig. 5).

Before restarting the unit, check that the shaft is not jammed and fill the pump casing completely with liquid.

8.2. Dismantling the system

Close the suction and delivery gate valves and drain the pump casing before dismantling the pump.

8.3. Dismantling the pump



Close the suction and delivery gate valves and drain the pump casing before dismantling the pump (par. 13 fig. 5).

For dismantling and re-assembly see construction in the cross section drawing.

9. DISPOSAL



The final disposal of the device must be done by specialized company.

Make sure the specialized company follows the classification of the material parts for the separation. Observe the local regulations and dispose the device accordingly with the international rules for environment protection.

10. SPARE PARTS

10.1. Spare-parts request

When ordering spare parts, please quote their designation, position number in the cross section drawing and rated data from the pump name plate (type, date and serial number).

The spare parts request shall be sent to Bedu Pompen BV by phone, fax, e-mail.

11. ESIGNATION OF PARTS

Nr.	Designation
14.00	Pump casing
14.04	Plug
14.06	O-ring
14.12	Plug
14.16	O-ring
14.20	O-ring
14.24	Screw
16.00	Suction casing
16.14	Plunger
16.15	Spring
16.16	O-ring
16.17	Valve
20.00	Delivery casing
22.12	O-ring
22.16	O-ring
25.01	First stage casing
25.02	Stage casing (complete)
25.05	Last stage casing
25.10	Washer for missing impeller
25.11	First stage spacer
28.00	Impeller
28.04	Impeller nut
28.08	Washer
34.00	Casing cover
36.00	Mechanical seal
36.51	Retaining ring, split
36.52	Shoulder ring
46.00	Deflector
64.15	Spacer sleeve
70.00	Lantern bracket
73.00	Ball bearing
76.00	Motor casing with winding
76.04	Cable gland
76.16	Support
76.20	Pin
76.54	Terminal box, set
78.00	Shaft with rotor packet
81.00	Ball bearing
82.00	Motor end shield
82.04	Compensating spring
88.00	Motor fan
90.00	Fan cover
90.04	Screw
92.00	Tie-bolt
94.00	Capacitor
98.00	Terminal box cover
98.08	Gasket

Changes reserved.

12. TROUBLESHOOTING

OFF



WARNING: Turn off the power supply before performing any operations.

Do not allow the pump or motor to run when dry even for a short period.

Strictly follow the user instructions and if necessary contact an authorised service centre.

GB

PROBLEM	PROBABLE CAUSES	POSSIBLE REMEDIES
1) The motor does not start	1a) Unsuitable power supply 1b) Incorrect electrical connections 1c) Engine overload protective device cuts in. 1d) Blown or defective fuses 1e) Shaft blocked 1f) If the above causes have already been checked, the engine may be malfunctioning	1a) Check that the mains frequency and voltage correspond to the electrical characteristics shown on the indicator plate 1b) Connect the power supply cable to the terminal board correctly. Check that the thermal overload protection is set correctly (see data on the engine indicator plate) and make sure that the fuseboard upline of the engine has been properly connected 1c) Check the power supply and make sure that the pump shaft is turning freely. Check that the thermal overload protection has been set correctly (see engine indicator plate) 1d) Replace the fuses, check the electric power supply and points a) and c) 1e) Remove the cause of blockage as indicated in the "Blocked pump" instruction booklet 1f) Repair or replace the engine by applying to an authorised service centre
2) Pump blocked	2a) Prolonged periods of inactivity with formation of rust inside the pump 2b) Presence of solid bodies in the pump rotor 2c) Bearings siezed	2a) Rotation may be started directly from the pump shaft or from the joint (remember to turn off the electricity supply first) or contact an authorised service centre 2b) If possible, dismantle the pump casing and remove any solid foreign bodies inside the rotor, if necessary contact an authorised service centre 2c) If the bearings are damaged replace them or if necessary contact an authorised service centre
3) The pump functions but no water comes out	3a) Possible infiltration of air from suction tube connections, drain plugs or filling of pump or from the gaskets of the suction pipe 3b) Foot valve blocked or suction pipe not fully immersed in liquid 3c) Suction filter blocked	3a) Check which part is not tight and seal the connection adequately 3b) Clean or replace the bottom valve and use a suction pipe suitable for the application 3c) Clean the filter, if necessary, replace it . See point 2a) also.
4) Insufficient flow	4a) Pipes and accessories with diameter too small causing excessive loss of head 4b) Presence of deposits or solid bodies in the internal passages of the rotor 4c) Rotor deteriorated 4d) Worn rotor and pump case 4e) Excessive viscosity of the liquid pumped (if other than water) 4f) Incorrect direction of rotation 4g) Suction head excessive in relation to the suction capacity of pump 4h) Suction pipe too long	4a) Use pipes and accessories suitable for the specific application 4b) Clean the rotor and install a suction filter to prevent other foreign bodies from entering 4c) Replace the rotor, if necessary, contact an authorised service centre 4d) Replace the rotor and the pump casing 4e) The pump is unsuitable 4f) Invert the electrical connections on the terminal board or control panel 4g) Try to close the feeder gate partially and/or reduce the difference in level of the pump and the liquid being aspirated 4h) Bring the pump closer to the suction tank so as to use a shorter pipe. If necessary use a pipe of a wider diameter
5) Noise and vibrations from the pump	5a) Rotating part unbalanced 5b) Worn bearings 5c) Pump and pipes not firmly attached 5d) Flow too strong for the diameter of the delivery pipe 5e) Functioning in cavitation 5f) Unbalanced power supply 5g) Incorrect alignment of pump-motor unit	5a) Check that no solid bodies are obstructing the rotor 5b) Replace the bearings 5c) Anchor the delivery and suction piping as needed 5d) Use bigger diameters or reduce the pump flow 5e) Reduce the flow by adjusting the feeder gate and/or using pipes with a bigger internal diameter. See point 4g) too 5f) Check that the mains voltage is right 5g) If necessary, the unit must be re-aligned
6) Leakage from the mechanical seal	6a) The mechanical seal has functioned when dry or has stuck 6b) Mechanical seal scored by presence of abrasive parts in the liquid pumped 6c) Mechanical seal unsuitable for the type of application 6d) Slight initial drip during filling or on first start-up	In cases 6a), 6b) and 6c), replace the seal, if necessary contact an authorised service centre 6a) Make sure that the pump casing (and the suction pipe if the pump is not self-priming) are full of liquid and that all the air has been expelled. See point 5 e) too. 6b) Install a suction filter and use a seal suited to the characteristics of the liquid being pumped. 6c) Choose a seal with characteristics suitable for the specific application 6d) Wait for the seal to adjust to the rotation of the shaft. If the problem persists, see points 6a), 6b) or 6c) or contact an authorised service centre.

13. Installation examples

Automatic regulator

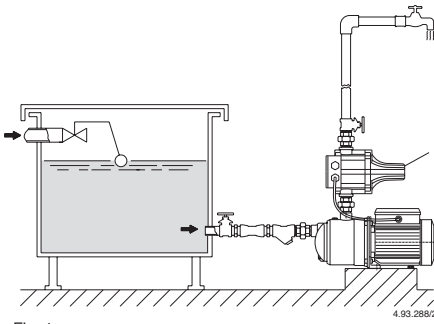

Fig. 1
Positive suction head operation

4.93.288/2

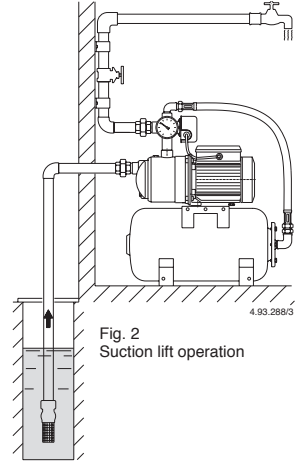

Fig. 2
Suction lift operation

4.93.288/3

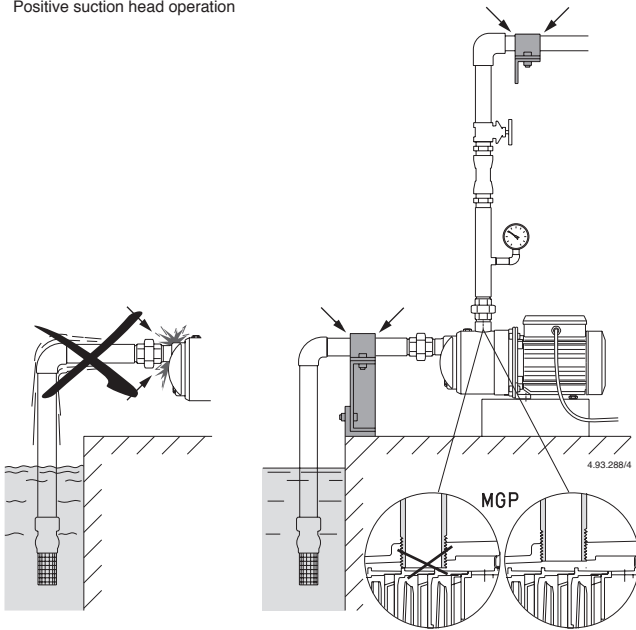

Fig. 3
Supports and clamps for pipelines

4.93.288/4

MGP

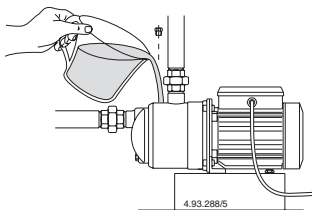

Fig. 4
Filling

4.93.288/5

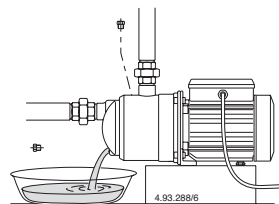

Fig. 5
Draining

4.93.288/6



EC - Declaration of Conformity

Manufacturer Details

Tradename

Bedu Pompen BV

Address

Poort van Midden Gelderland Rood 10, 6666 LT, Heteren, Netherlands

Product Details

Product Name

Centrifugal pumps

Model (+series) Name

MKP, MGP, MKA series

Applicable Standards Details

Directives

2006/42/EC (Machinery Directive)
2014/35/EU (Low Voltage Directive)
2014/30/EU (Electromagnetic compatibility)

Standards

EN-ISO 12100:2010
EN-IEC 60204-1:2006
EN 809+A1/C1

Additional information

No further details.

Declaration

We hereby declare under our sole responsibility that the product(s) mentioned above to which this declaration relates complies with the above mentioned standards and Directives.

Business Unit Manager: Issued Date:

01/10 2014

BEDU Pompen BV

Poort van Midden Gelderland Rood 10
6666 LT Heteren

Tel : +31 (0)88 - 4802 900

Fax : +31 (0)88 - 4802 901

E-mail : info@bedu.nl

Website : www.bedu.eu

Marco Breunissen

Signature of representative(s)



BEDU
≡ P O M P E N ≡

made for your process

- Expert advice
- A customer-oriented organization that adapts to the requirements and wishes of your organization
- Innovative and customized solutions
- Breakdownservice, 24 hours a day, 7 days a week
- Technical service with extensive test facilities, working from our own workplace or at your location
- A fast and appropriate solution for all your issues
- Wide range of liquid pumps
- Repair, maintenance and revision

BEDU POMPEN B.V.
Poort van Midden Gelderland Rood 10
6666 LT HETEREN
Nederland
Telefoon +31 (0)88 4802 900
E-mail info@bedu.eu

WWW.BEDU.EU

BEDU BELGIUM B.V.B.A.
Industriepark-West 75
9100 SINT-NIKLAAS
België
Telefoon +32 (0)3 80 87 980
E-mail info@bedu.be

WWW.BEDU.BE

