

**BEDU**  
≡ POMPEN ≡

Magnetic drive  
Submersible  
Chemical Pump

**GWN series**



**made for your process**

# The World's Exceptional Magnetic Drive Submersible Chemical Pump



## The world's exceptional corrosion-resistant submersible pump for use in strong acids and alkalis

Our submersible pump has a structure in which carbon fiber reinforced polypropylene (CFR PP) is used for the main pump body, and SiC, high purity ceramics and PTFE for critical parts, with no metal is used in wet parts kit, and therefore can be used in strong acidic and alkaline solutions.

## Submerge is a Seal-less Pump

Although mechanical seals are generally used as the seals in submersible pumps, in most cases, problems related to seals are not detected until the pump fails, as inspections are not executed regularly. This situation may inevitably result in comprehensive damage as a result of liquid entry into the motor chamber. The magnetic drive used in Submerge has safety features that prevent the entry of liquids into the motor chamber.

## Submerge has a "disk-type magnet drive system" that is optimal for submersible pumps

In horizontal magnetic drive pumps, a structure is generally provided with a coupling from the outer side of the cylindrical driven magnet (impeller portion on the pump side) and the drive magnet on the plate-shaped motor side.

Bedu has adopted a "disk type magnet drive system".

The "disk type magnet drive system" achieves the simple pump water flow realizes a structure that is resistant to air locks or slurry.

## Submerge is Oil Free

The seal-less magnetic drive pump does not include the oil-bath mechanical seals that are typical of general submersible pumps. Therefore, we provide a safe pump without the risk of oil leakage due to wear of the mechanical seal and without oil contamination.

## Submerge has a high temperature specification as standard

An H-type motor is fitted as standard! Therefore the standard specifications allow for use up to a liquid temperature limit of 75°C. Submerge has applications that are difficult for self-priming pumps such as high-temperature liquids that tend to foam, applications for pumping from deep pits, and the like.

The pump can be used very safely in these situations.

## Structural Features of Submerge

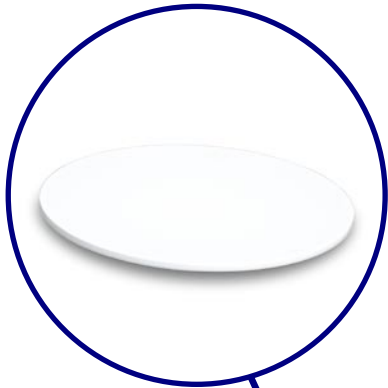

### Separating board

Disk type magnet drive system  
A drive disk-shaped magnet and a driven magnet (disk-shaped impeller), and these two disk-shaped magnets rotate while gripped by a hardened ceramic separator. The simple pump water flow realizes a structure that is resistant to air locks or slurry.

### All "Original" down to the last bolt

The specialized bolts used in Submerge are formed from stainless steel bolts molded with carbon fiber reinforced polypropylene (CFR PP). Our original bolts are the results of research into combining metallic strength with high corrosion resistance. An O-ring is used in the mating portions with cap nuts that are molded in the same way to realize perfect strength and corrosion resistance.

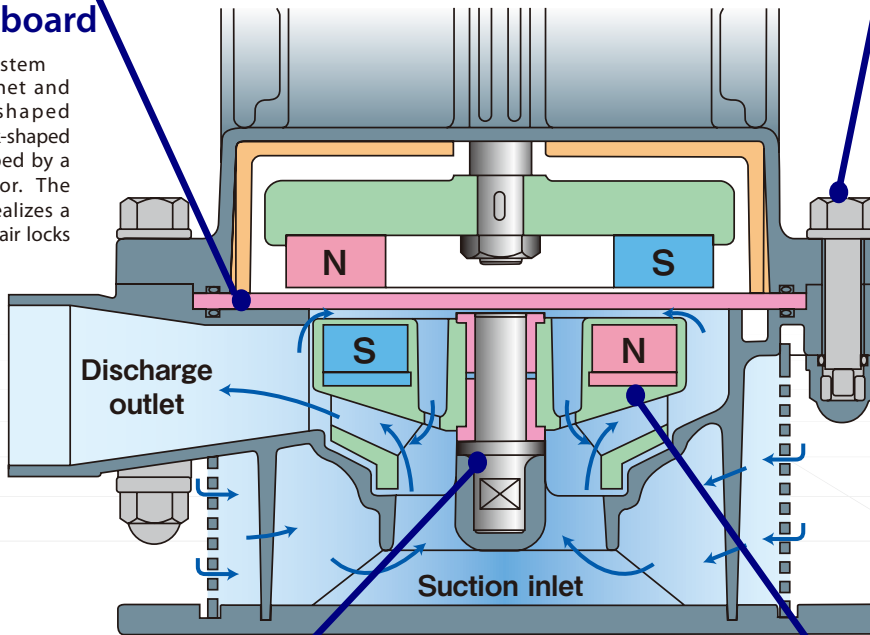

### Impeller

The impeller has a structure in which a magnet is molded into an inner portion by injection molding using carbon fiber reinforced polypropylene (CFR PP). A CFR-PTFE (carbon filled Teflon resin) bearing that slides with the shaft is press-fitted to a central portion of the impeller.

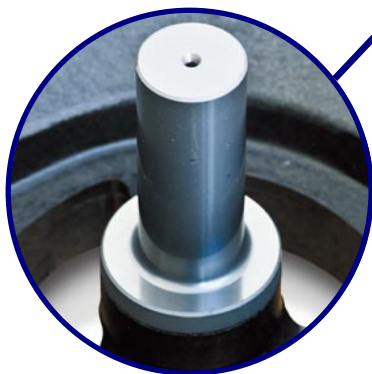

### Submerge uses SiC (silicon carbide) shaft as standard

Since SiC has extremely high resistance in relation to thermal impact and exhibits higher heat shock resistance than ceramics, it is perfectly adapted for use in magnet shaft of the submersible pumps due to wear resistance performance.



\*Specific gravity can be adjusted by trimming the impeller.

\*Different voltages are also available. Please contact our sales representative for further details.

## Model Designation

Example

# BD-50 02 GWN-CP - A D 6 1 - HP - V

①      ②      **Type**      ③      ④      ⑤      ⑥      ⑦      ⑧      ⑨

- ① Bore: 50 = 50A
- ② Motor output: 02 = 1.1kW
- ③ Main cover material: CFR PP
- ④ Bushing material:  
R = PTFE A = Alumina Ceramic
- ⑤ O-ring material: E = EPDM D = FPM
- ⑥ Frequency: 5 = 50Hz 6 = 60Hz
- ⑦ Liquid specific gravity:  
1 = 1.1 3 = 1.3 5 = 1.5
- ⑧ Impeller:  
no marking = standard  
HP = high pressure type
- ⑨ Special markings:  
(e.x.) V = different voltage

\*Special markings: markings other than the markings described above relate to specific user characteristics or special use as a result of partial modifications.

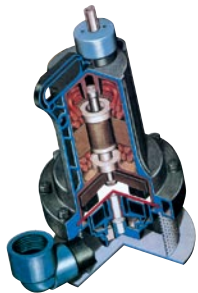

## Standard Specifications

Type	Frequency	Standard Specification		Motor output	Phase x Voltage	Discharge opening diameter (kW)	Weight (kg)
		Total Head (m)	Capacity (L/min)				
5002GWN	50Hz	8.3m	200L/min	1.1kW	200V x 3 Phase	50mm	26kg
5002GWN	60Hz	8.3m	200L/min		200/220V		
5002GWN-HP	60Hz	11.9m	100L/min		x3 Phase		

## Exploded View

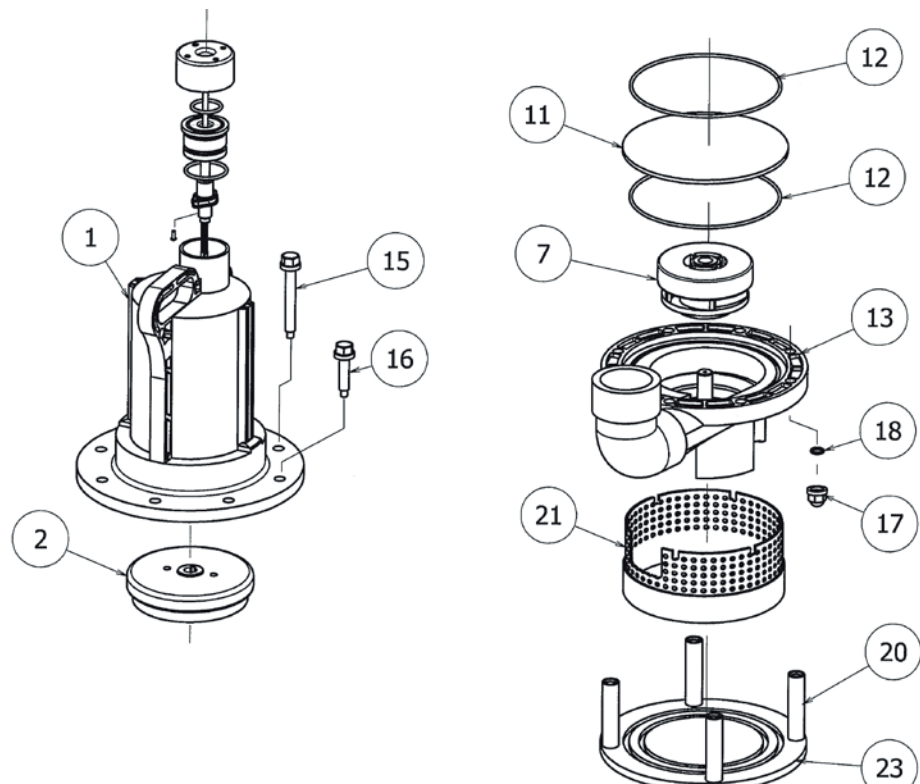

# Dimensions

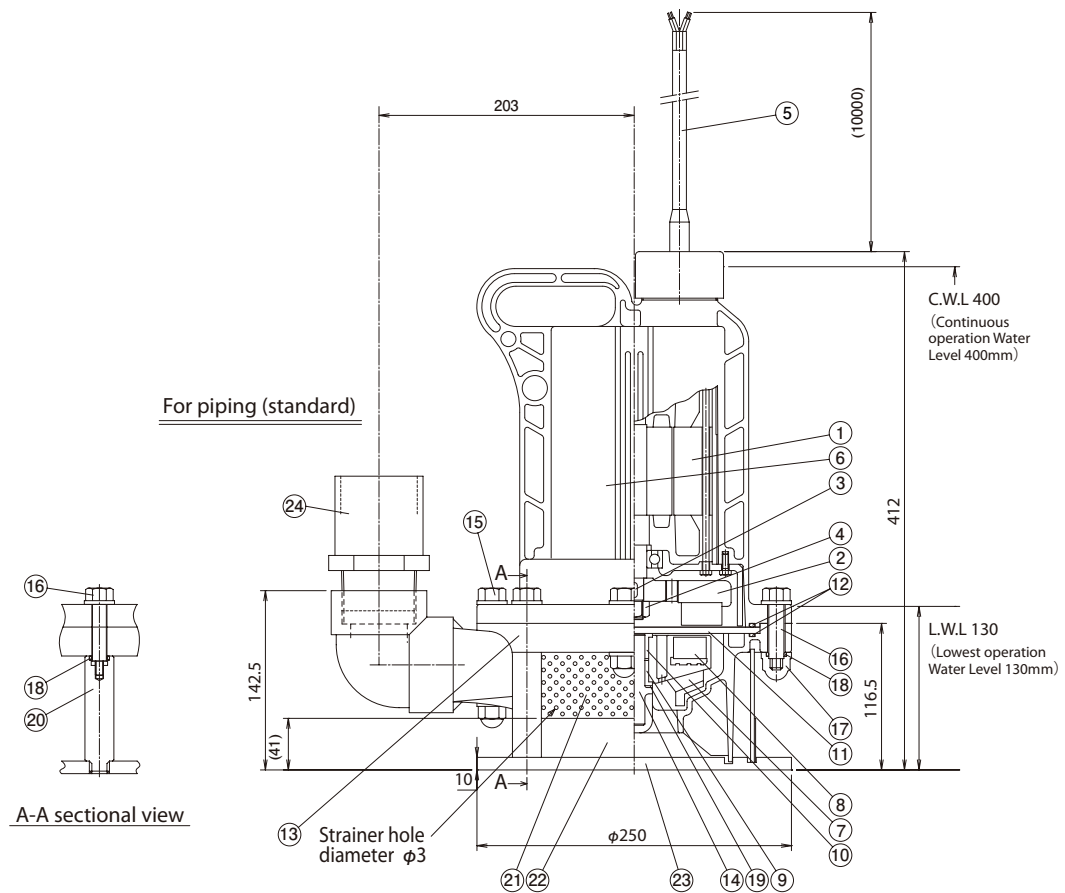

※ Measurements are subject to change without notice.

## Part List

No.	Part Name	Material
①	Motor	FC Dry induction type
②	Motor side magnet	Ferrite magnet
③	Motor side magnet key	SS
④	Motor side magnet nut	SS
⑤	Cabtire cable	2PNCT
⑥	Motor cover	CFR PP
⑦	Impeller	CFR PP
⑧	Impeller side magnet	Ferrite magnet
⑨	Front bearing	PTFE / ceramic
⑩	Rear bearing	PTFE
⑪	Separating board	Ceramic
⑫	O-ring	EPDM / FPM

No.	Part Name	Material
⑬	Casing	CFR PP
⑭	Pump shaft	SiC
⑮	Set bolt 92	CFR PP
⑯	Set bolts 52	CFR PP
⑰	Nuts for set bolt	CFR PP
⑱	O-ring	EPDM/FPM
⑲	Floating washer	PTFE (for ceramic bearing only)
⑳	Stand bolts	HT.PVC
㉑	Strainer	PP
㉒	Sludge fence	PP
㉓	Bottom board	PP
㉔	50A valve socket	PVC

# Performance Curves

**5002GWN 50Hz**

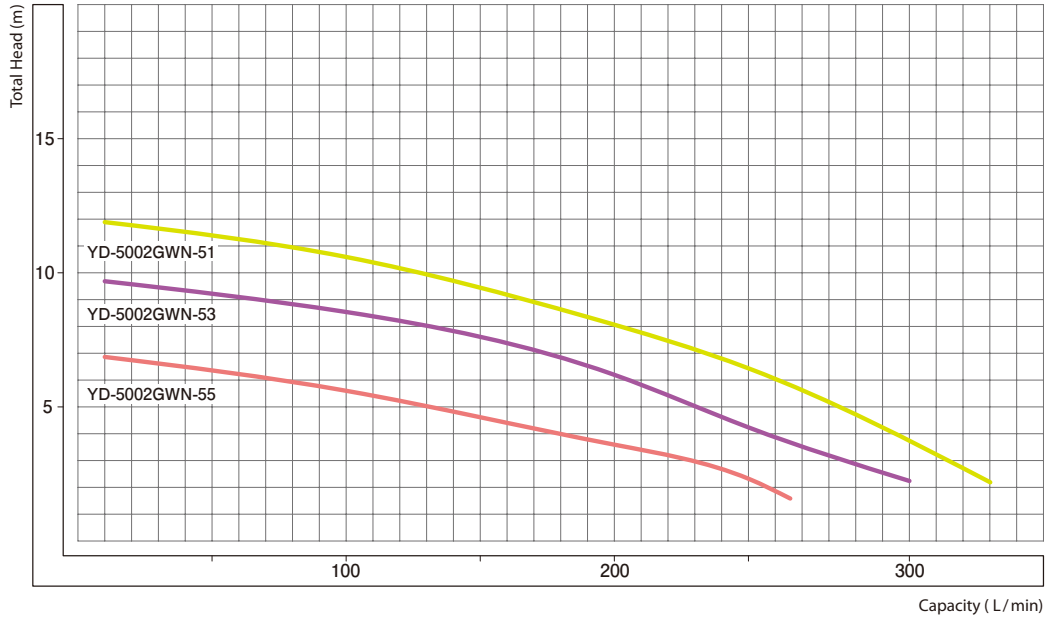

**5002GWN 60Hz**

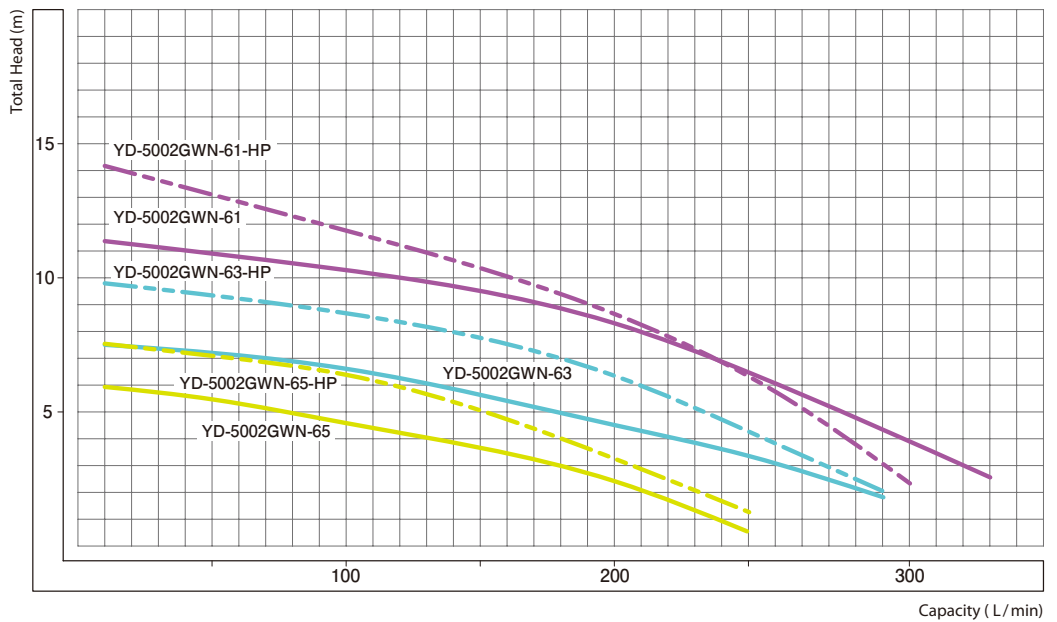

# Examples of USE

For Pumping from a sump pit at a breakwater

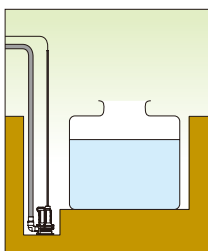

For Pumping from a deep tank

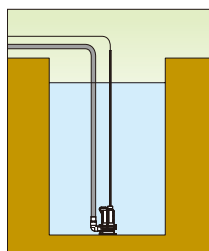

For Pumping formy liquid from a tank

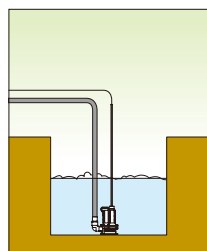

For mixing

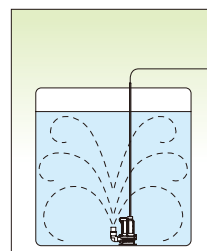

For Pumping from a chemical tank

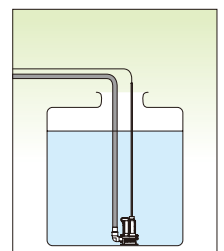

# Cautions

## Material and Corrosion Resistance

### 1. CFR PP (Carbon Fiber Reinforced Polypropylene)

The main material of SUBMERSE, CFR PP is generally used in acidic and alkaline applications. However, CFR PP may corrode in applications that use sulfuric acid, nitric acid, hydrofluoric acid, chromic acid and sodium hypochlorite, depending on the chemical's concentration. Please contact us for further inquiries.

### 2. Ceramic

High-purity ceramic with high corrosion resistance allows for acidic and alkaline applications.

### 3. EPDM and FPM (O-ring materials)

EPDM is for alkaline application and FPM for acidic application. These cannot be used in organic solvent solutions.

### 4. 2PNCT

The cable material is 2PNCT, and can be used in acids and alkalis except organic solvents.

## Operating Temperature Limit

The motor uses H-type insulation, and can be used under standard specifications up to temperatures of 75 °C.

## Safety Advice

1. A built-in thermal protector prevents excessive motor heat from overload operation or single-phase operation. However, as an additional protection, **always install a circuit breaker to prevent accidents caused by a short circuit.** The built-in thermal protector prevents a short circuit in liquid as well as motor burnout by shutting down the motor when it detects liquid entering into the pump.

\*Always check the motor's insulating resistance prior to pump operation.

2. **Never dismantle motor parts and cable connection. This will cause accidents from a short circuit.**

## Installation Method

Please refer to the piping right as reference to prevent water hammer.

**Continuous operation water level : 400mm** (when the whole motor section is immersed)

**Lowest operation water level : 130mm**

(although pumping is possible, since the cooling of the motor section is insufficient, please allow for operation not exceeding 10 minutes).

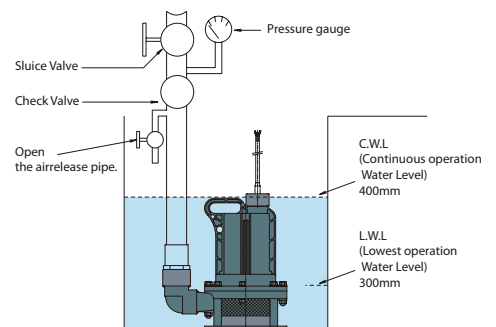

## Operational Precautions

1. Liquid with slurry accelerates the progression of bearing wear. For sedimentation tanks, keep the pump raised on platform or remove slurry before installation in order to prevent slurry from entering into the pump. (Bearing can be replaced easily. Use ceramics bearing for liquid with slurry.)
2. Submerge the pump fully. Open-air operation will cause pump failure.
3. When the pump operates with a check valve on the discharge piping, air is trapped in the pump, resulting in dry running. If a check valve is required, install an air release pipe below the check valve.
4. Exposure of the pump part to the air during operation will result in inadequate cooling of the motor, and damage the resin motor cover.
5. Always check the liquid level gauge before operation. Malfunction of the liquid level gauge will cause dry running.
6. Do not remove the strainer from the pump during operation. Always clean the strainer to prevent clogging. A clogged strainer could cause failure of pumping and motor burnout.
7. Do not extend the cable without confirming the electric cable diameter in order to prevent voltage drops.

## Handling Precautions

Always handle the pump with care, as the main body of this pump has resin coating. Do not cause any damage by dropping the pump or hitting it against an object. When lifting the pump from a tank, use the rope provided. Never pull the cable.

**Improper handling of the pump and parts could result in pump failure and injury to the user of the product.**

## Checking the direction of rotation

1. SUBMERSE uses a magnet drive configuration, so dry running will damage the bearing and the shaft, and there is the possibility of heat deformation to resin sections. The three-phase pump may turn in a reverse direction due to the wiring connections. When turning in reverse, there is a 60% reduction in the water discharge amount compared with normal operation. In addition, it is possible to confirm that the pump is turning in a reverse direction if the current value is low. When these methods of checking are not available, as shown in Fig. ①, checking can be performed by suspending the pump with a rope in water, turning the pump to the ON and OFF positions to verify rotation in an opposite direction.
2. When turning in a normal direction, if the the pump is immediately turned ON, it will move towards the left when Fig. ② A is viewed from above. (During the checking process, pay attention to discharged liquid from the discharge pipe).

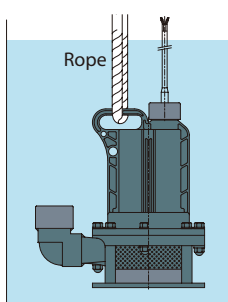

Figure ①

Hang the pump sunk in the container or the pit big enough and verify the rotative direction.

Figure ② A  
The correct direction

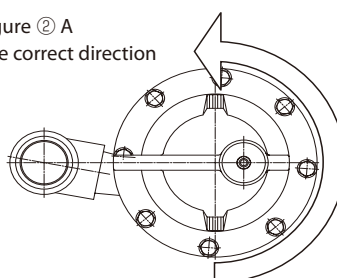
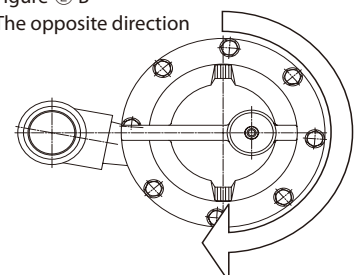

Figure ② B  
The opposite direction



The logo consists of the word 'BEDU' in a large, bold, white sans-serif font, with 'POMPEN' in a smaller, white sans-serif font below it. The text is centered within a dark teal square, which is itself centered within a white square border.

**BEDU**  
POMPEN

## made for your process

- Deskundig advies
- Een klantgerichte organisatie die zich aanpast aan de eisen en wensen van uw organisatie
- Innovatieve en maatwerkoplossingen
- Storingsdienst 24 uur per dag, 7 dagen in de week
- Technische dienst met uitgebreide testfaciliteiten, werkend vanuit onze eigen werkplaats of bij u op locatie
- Een snelle en passende oplossing voor al uw vraagstukken
- Breed assortiment vloeistofpompen
- Reparatie, onderhoud en revisie

Versie 2 - 2019

BEDU POMPEN B.V.  
Poort van Midden Gelderland Rood 10  
6666 LT HETEREN  
Nederland  
Telefoon +31 (0)88 4802 900  
E-mail [info@bedu.nl](mailto:info@bedu.nl)

[WWW.BEDU.NL](http://WWW.BEDU.NL)

BEDU BELGIUM B.V.B.A.  
Industriepark-West 75  
9100 SINT-NIKLAAS  
België  
Telefoon +32 (0)3 80 87 980  
E-mail [info@bedu.be](mailto:info@bedu.be)

[WWW.BEDU.BE](http://WWW.BEDU.BE)

